

WASHING HEADS CATALOGUE



euspray®

by Eurospray spray and filter technology SL

**SPRAYING
NOZZLES**

**BOQUILLAS
DE ASPERSIÓN**

**UGELLI
SPRUZZATORI**



**ATOMIZING
NOZZLES**

**BOQUILLAS
ATOMIZADORAS**

**UGELLI
ATOMIZZATORI**



**TANK CLEANING
HEADS**

**CABEZAS DE LAVADO
DE TANQUES**

**TESTE LAVAGGIO
SERBATOI**



**PRODUCTS FOR
PAPER MILL**

**PRODUCTOS PARA
FABRICA DE PAPEL**

**PRODOTTI PER
CARTIERE**



INDICE INDEX INDICE

INFORMAZIONI TECNICHE TECHINCAL INFORMATION INFORMACION TECNICA

p. 2

SISTEMI DI LAVAGGIO FISSI FIXED HEADS BOQUILLAS FIJAS

p. 5

SFERE DI LAVAGGIO ROTANTI ROTATING WASHING HEADS BOQUILLAS ROTATIVAS

p. 9

PROFILO AZIENDALE COMPANY PROFILE PERFIL DE LA EMPRESA

EUSPRAY rappresenta la soluzione “**Good Quality at Economical Prices**” che offre teste di lavaggio, ugelli spruzzatori, accessori e filtri statici e autopulenti della massima qualità a prezzi economici.

Lo scopo della nostra azienda, creata nel 2008, è quello di promuovere la vendita dei prodotti a livello mondiale direttamente o tramite rappresentanti e distributori locali.

La nostra azienda partner, specializzata nella fabbricazione dei prodotti, vanta più di 40 anni di esperienza tecnica nella progettazione e produzione di ugelli spruzzatori, accessori e filtri utilizzati nelle industrie di produzione e trasformazione di tutto il mondo. La collaborazione delle due aziende, che si occupano rispettivamente della commercializzazione e della produzione, permette:

- L’ottimizzazione dei costi commerciali e la creazione di costi competitivi.
- Soluzioni tecniche mirate
- Facile accesso ai prodotti richiesti
- Gestione veloce ed efficiente di ordini e richieste

EUSPRAY represents “**Good Quality at Economical Prices**”.

Washing heads, spray nozzles, accessories static and self cleaning filters are manufactured to the highest standards and offered at realistic prices.

Created in 2008, the company’s mission is to promote the sale of its products worldwide either directly or through agents and local distributors.

Its sister company, specializing in the manufacturer of the products has over 40 years of technical expertise in the design and manufacture of spray nozzles, accessories and filters used in the manufacturing and process industries world Wide.

The two companies working in harmony, one responsible for marketing and the other responsible for manufacturing results in:

- *Lower overheads and costs creating competitive pricing.*
- *Focused technical solutions.*
- *Easy access to the required products.*
- *Fast and efficient turn round of orders and requests.*

EUSPRAY rappresenta la “**buena calidad a precios económicos**”. Las boquillas de pulverización, accesorios, filtros estáticos y de auto-lavado se producen con los estándares más elevados y se ofrecen a precios realistas. Creada en 2008, la misión de esta empresa es promover las ventas de sus productos en todo el mundo ya sea directamente o mediante agentes o distribuidores locales. Su empresa hermana, que se especializa en la manufactura de productos, tiene 40 años de experiencia técnica en el diseño y manufactura de boquillas de pulverización, accesorios y filtros empleados en la manufactura y procesos industriales en todo el mundo. Dos empresas que trabajan en armonía, siendo una de ellas responsable de la comercialización y la otra, responsable del proceso de fabricación. Por consiguiente:

- Los gastos generales y los costes son inferiores, por lo que los precios son más competitivos.
- Las soluciones técnicas son precisas.
- El acceso a los productos solicitados es sencillo
- Una respuesta rápida y eficiencia en los pedidos y peticiones.

TESTE ROTANTI

La velocità di rotazione dipende dalla pressione del liquido del lavaggio una rotazione troppo rapida causa la rottura del getto in molte gocce e la perdita della forza d'impatto.

SENZA SFERE

La rotazione avviene anche a una pressione molto bassa (inferiore a 1 bar). Tali teste sono capaci di ruotare in qualsiasi posizione e orientamento in cui sono installate. Possono essere costruite in acciaio inox con trattamento antiusura e un basso coefficiente di attrito o in materia plastica di alta qualità (PTFE). Sono disponibili per serbatoi di ogni dimensione e con diversi tipi di connessioni e coperture.

SU UNA SINGOLA CORONA DI SFERE

La rotazione della testa è possibile anche a bassa pressione (anche intorno agli 0,5 bar). La rotazione è molto più facile e permette un lavaggio adeguato e una buona copertura anche per serbatoi di grandi dimensioni. Posizionamento unicamente verticale e connessione posta sulla parte superiore. Costruite completamente in acciaio inox AISI 316, sono disponibili in diverse dimensioni e connessioni per il lavaggio di serbatoi di dimensioni medio - grandi.

SU DOPPIA CORONA DI SFERE

Le teste rotanti dotate di due file di sfere sono capaci di ruotare in qualsiasi posizione e orientamento in cui sono installate. Questo può rappresentare un grande vantaggio poiché esse non devono necessariamente essere posizionate verticalmente con una connessione sulla parte superiore del serbatoio. Una bassa pressione (anche inferiore agli 0,5 bar) è sufficiente per permettere la rotazione. Costruite in acciaio inox lucidato AISI 316, sono disponibili in diverse dimensioni e connessioni per il lavaggio di serbatoi di piccole, medie e grandi dimensioni. La loro particolare struttura interna e il grado di rugosità della superficie di tutti i componenti riduce il rischio di formazione di batteri dovuto al ristagno idrico.

ROTATING HEADS

The rotational speed depends on the washing fluid pressure a too fast rotation causes the jet breakage in many drops and the loss of impact force.

WITHOUT SPHERES

The rotation takes place also a very low pressures (less than 1 bar). They are able to rotate in any position and orientation with which they are installed. They can be made of stainless steel with an special anti-wear treatment and a low coefficient of friction, or in plastic material of high quality standards (PTFE). They are available for tanks of any size and with different types of connections and covers.

ON ONE SPHERE TRACK

The head rotation is possible even at low pressure (also around 0,5 Bar). The rotation is much easier and allows an adequate washing and a good cover also for tanks of great size. Only vertical positioning and connection placed on the upper part. Made entirely in stainless steel AISI 316, they are available in different sizes and connections for the washing of medium-large sized tanks.

ON TWO SPHERE TRACKS

The washing heads equipped with two sphere rows are able to rotate in any position and orientation in which they are installed. This might be a great advantage since they do not necessarily have to be positioned vertically with a connection of the upper part of the tank. A low pressure (even less than 0,5 bar) is sufficient to impart the rotation. Made in polished stainless steel AISI 316, they are available in different sizes and connections for the washing of small, medium and large-sized tanks. Their particular internal conformation and the degree of superficial roughness of all components reduce the risk of bacterial formations due to the little water stagnations.

BOQUILLAS ROTATIVAS

La velocidad de giro depende de la presión del líquido de lavado un giro excesivamente rápido causa la rotura del jet en muchas gotas y la pérdida de fuerza.

SIN ESFERAS

La rotación también produce una presión muy baja (inferior a un bar). Pueden girar en cualquier posición y orientación en que sean instalados. Pueden estar echos de acero inoxidable con un tratamiento especial anti desgaste y un coeficiente bajo de fricción, o en un material plástico de un estándar de calidad superior (PTFE). Están disponibles para tanques de cualquier medida y con diferentes tipos de conexiones y tapas.

EN UNA PISTA ESFÉRICA

La rotación del cabezal es posible incluso a presiones bajas (también alrededor de los 0,5 Bar). La rotación es mucho más fácil y permite un lavado más adecuado y una buena cobertura para tanques de grandes dimensiones. Posicionamiento únicamente vertical y una conexión situada en la parte superior. Hecho íntegramente de acero inoxidable AISI 316, están disponibles en diferentes tamaños y conexiones para el lavado de tanques de grandes y medianas dimensiones.

EN DOS PISTAS ESFÉRICAS

Los cabezales de lavado equipados con dos hileras esféricas permiten la rotación en cualquier posición y orientación en que estén instalados. Esto podría suponer ser una gran ventaja ya que no necesariamente tienen que ser posicionados de forma vertical con una conexión de la parte superior del tanque. Una presión baja (incluso inferior a los 0,5 bar) es suficiente para posibilitar la rotación. Fabricadas en acero inoxidable pulido AISI 316, están disponibles en diferentes tamaños y conexiones para el lavado de tanques de dimensiones pequeñas, medianas y grandes. Su particular configuración interna y el grado de robustez superficial de sus componentes reduce el riesgo de formación de bacterias debido al estancamiento de pequeñas cantidades de agua.

**SISTEMI DI
LAVAGGIO FISSI**
FIXED HEADS
BOQUILLAS FIJAS

 **LSMOD7**
SFERE FISSE
FIXED HEADS
BOQUILLAS FIJAS p. 6

 **FLS**
SFERE FISSE
FIXED HEADS
BOQUILLAS FIJAS p. 6

 **MB9S**
UGELLI A SPIRALE
SPIRAL NOZZLES
BOQUILLAS ESPIRALES p. 7

 **7B**
UGELLO CONO PIENO MULTIPLO
MULTIPLE FULL CONE NOZZLES
BOQUILLAS MULTIPLE p. 8

LSMOD7

Caratteristiche

Il sistema di lavaggio tramite diffusori è veloce, semplice ed efficace: permette di lavare con acqua calda e detersivi. Essi facilitano l'automazione dei programmi lavaggio e l'assenza di parti mobili evita il rischio di usura anche dopo lunghi periodi d'utilizzo.

Applicazioni

- Lavaggio serbatoi
- Pasorizzatori

Materiali

- Aisi316L

Conessioni

- Filettata femmina
- Clip

Copertura:

Characteristics

The cleaning system by means of diffusers is fast, simple and effective: it allows to wash with hot water and detergents. They facilitate the automation of washing programs and the absence of movable parts avoids the risk of wear even after long periods of use.

Application:

- Tank washing
- Pasteurizadores

Materials:

- Aisi316L

Connection:

- Female Threaded
- Clip

Coverage:

Características

El sistema de lavado por medio de difusores es rápido, simple y efectivo: permite lavar con agua caliente y detergentes. Facilitan la automatización de programas de lavado y la ausencia de partes móviles evita el riesgo de rotura incluso después de largos periodos de uso.

Aplicación:

- Lavado de tanques
- Pasteurizers

Materiales:

- Aisi316L

Conexiones:

- Rosca hembra
- Clip

Cobertura:

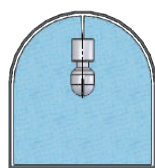

360°

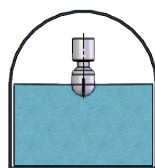

180° DOWN

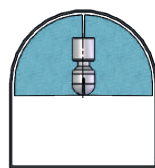

180° UP

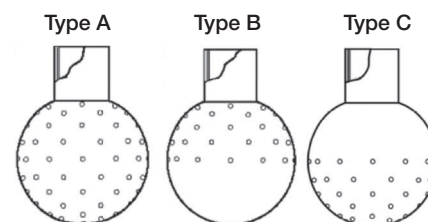

FLS

Caratteristiche

Il modello FLS è costruito da barra piena con spessori maggiori per garantire il funzionamento a pressioni elevate.

Applicazioni

- Lavaggio serbatoi
- Pasorizzatori

Materiali

- Aisi316L, Aisi303
- Altri a richiesta

Characteristics

The FLS model is built from solid bar with greater thickness to guarantee high pressure operation.

Application:

- Tank washing
- Pasteurizadores

Materials:

- Aisi316L, Aisi303
- Other on request

Características

El modelo FLS está construido de una barra sólida con mayor grosor para garantizar el funcionamiento a alta presión.

Aplicación:

- Lavado de tanques
- Pasteurizers

Materiales:

- Aisi316L, Aisi303
- Otros bajo pedido

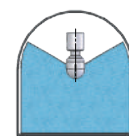
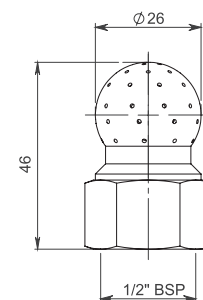

240° DOWN

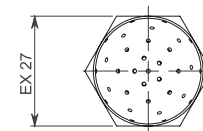

| Mod. | Free Passage (mm) | Capacity (lpm) at different pressure (bar) | | | | Connection | Coverage |
|----------|-------------------|--|------------|-----|-----|------------|----------|
| | | 2 | 3 | 4 | 5 | | |
| A3FLS22 | 0,8 | 18 | 22 | 25 | 28 | 1/2" BSP | 240° |
| A3FLS34 | 1,0 | 28 | 34 | 39 | 44 | 1/2" BSP | 240° |
| A3FLS70 | 1,5 | 57 | 70 | 81 | 90 | 1/2" BSP | 240° |
| A3FLS110 | 2,0 | 90 | 110 | 127 | 142 | 1/2" BSP | 240° |
| A3FLS145 | 2,3 | 118 | 145 | 167 | 187 | 1/2" BSP | 240° |

MB9S

Caratteristiche

Il nuovo ugello idraulico MB9S attua un getto a cono vuoto di grande angolo (fino a 180°), anche con pressioni di acqua piuttosto basse (da 0,5 bar in su).
Gli ugelli a spirale generano gocce veloci con media/grossa dimensione che creano una buona forza di impatto, per questo possono essere utilizzati per il lavaggio di piccoli serbatoi.

Applicazioni

- Lavaggio cisterne
- Pastorizzatori

Materiali

- Aisi316, PTFE, PP, PVC, Ottone

Characteristics

The new hydraulic nozzle model MB9S produces a hollow cone jet with a wide spray angle (by 180°) even at low water pressure (from 0,5 bar and over).
The spiral nozzles generate fast drops with medium / large size which create a good impact force, for this they can be used for washing small tanks.

Application:

- Tank washing
- Pasteurizadores

Materials:

- Aisi316, PTFE, PP, PVC, Brass

Características

La nueva boquilla hidráulica MB9S se aplica un chorro de gran ángulo de cono vacío (hasta 180°), incluso con la presión de agua más bien baja (0,5 bar. y superiores).
Las boquillas en espiral generan gotas rápidas con tamaño medio/grande que crean una buena fuerza de impacto, por lo que se pueden usar para lavar tanques pequeños.

Aplicación:

- Lavado de tanques
- Pasteurizers

Materiales:

- Aisi316, PTFE, PP, PVC, Latón

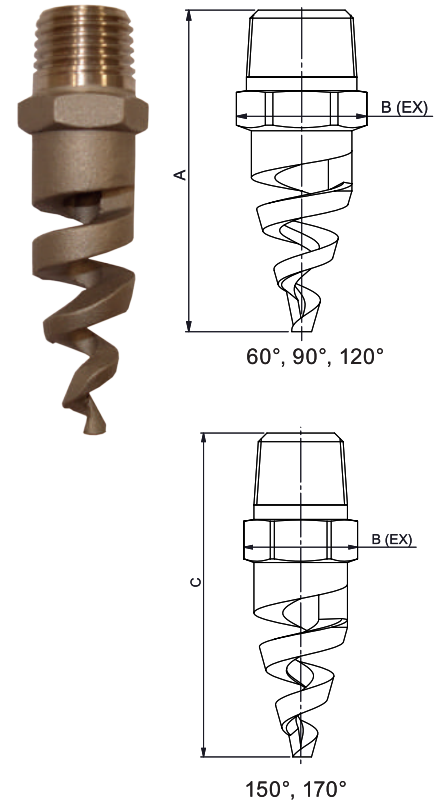

| Mod. | Capacity (lpm) at different pressure (bar) | | | | | | | | POSSIBLE ≤ 3 Bar | DIMENSIONS (mm) | |
|-------------------------|--|-----|-----|------------|-----|-----|-----|-----|---------------------------|-----------------|------------------|
| | 0,5 | 1 | 2 | 3 | 5 | 8 | 10 | 15 | | C | |
| | | | | | | | | | | 150° - 170° | 60° - 90° - 120° |
| 1/4 MB9 - 6 - S | 2 | 3 | 4 | 6 | 7 | 9 | 10 | 12 | 60 - 90 - 120 - 150 - 170 | 54 | 48 |
| 1/4 MB9 - 8 - S | 4 | 6 | 8 | 10 | 13 | 17 | 19 | 23 | 60 - 90 - 120 - 150 - 170 | 54 | 48 |
| 1/4 MB9 - 10 - S | 6 | 9 | 13 | 16 | 20 | 26 | 29 | 35 | 60 - 90 - 120 - 150 - 170 | 54 | 48 |
| 3/8 MB9 - 6 - S | 2 | 3 | 4 | 6 | 7 | 9 | 10 | 12 | 60 - 90 - 120 - 150 - 170 | 54 | 48 |
| 3/8 MB9 - 8 - S | 4 | 6 | 8 | 10 | 13 | 17 | 19 | 23 | 60 - 90 - 120 - 150 - 170 | 54 | 48 |
| 3/8 MB9 - 10 - S | 6 | 9 | 13 | 16 | 20 | 26 | 29 | 35 | 60 - 90 - 120 - 150 - 170 | 54 | 48 |
| 3/8 MB9 - 12 - S | 10 | 14 | 19 | 24 | 31 | 39 | 43 | 53 | 60 - 90 - 120 - 150 - 170 | 54 | 48 |
| 3/8 MB9 - 14 - S | 13 | 18 | 26 | 32 | 41 | 52 | 58 | 72 | 60 - 90 - 120 - 150 - 170 | 54 | 48 |
| 3/8 MB9 - 16 - S | 17 | 24 | 34 | 42 | 54 | 68 | 76 | 93 | 60 - 90 - 120 - 150 - 170 | 54 | 48 |
| 3/8 MB9 - 20 - S | 27 | 38 | 53 | 65 | 84 | 106 | 119 | 146 | 60 - 90 - 120 - 150 - 170 | 54 | 48 |
| 1/2 MB9 - 24 - S | 39 | 55 | 78 | 95 | 123 | 155 | 173 | 212 | 60 - 90 - 120 - 150 - 170 | 80 | 65 |
| 1/2 MB9 - 28 - S | 53 | 75 | 106 | 130 | 168 | 212 | 237 | 291 | 60 - 90 - 120 - 150 - 170 | 80 | 65 |
| 3/4 MB9 - 32 - S | 68 | 96 | 136 | 166 | 214 | 271 | 303 | 371 | 60 - 90 - 120 - 150 - 170 | 88 | 70 |
| 1 MB9 - 40 - S | 106 | 150 | 212 | 260 | 336 | 425 | 475 | 581 | 60 - 90 - 120 - 150 - 170 | 116 | 92 |
| 1 MB9 - 48 - S | 153 | 217 | 306 | 375 | 484 | 612 | 685 | 839 | 60 - 90 - 120 - 150 - 170 | 116 | 92 |

7B

Caratteristiche

Ugello multiplo costituito da un corpo con 7 testine di spruzzo rimovibili per pulizia o ricambio. Consente di ottenere una grande portata con gocce relativamente piccole.

Il cerchio di diametro **C** rappresenta la zona con il 65% della distribuzione.

Il cerchio di diametro **B** rappresenta la copertura totale.

Applicazioni

- Lavaggio cisterne
- Pastorizzatori

Materiali

- Aisi316L, Aisi303
- altri a richiesta

Characteristics

Multiple nozzle composed of body and 7 spray caps removable for cleaning or replacement.

It allows to obtain large flow capacity with relatively small drops.

Circle with diameter **C** is the area with 65% of flow capacity.

Circle **B** represents total covered area.

Application:

- Tank washing
- Pasteurizers

Materials:

- Aisi316L, Aisi303
- other on request

Características

Boquilla múltiple constituida por un cuerpo con 7 cabezales de rociado que pueden desmontarse para su limpieza o recambio.

Permite obtener una gran capacidad con gotas relativamente pequeñas.

El círculo de diámetro **C** representa la zona con el 65% de la distribución.

El círculo de diámetro **B** representa la cobertura total.

Aplicación:

- Lavado de tanques
- Pasteurizers

Materiales:

- Aisi316L, Aisi303
- otros bajo pedido

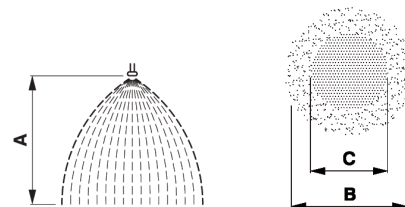
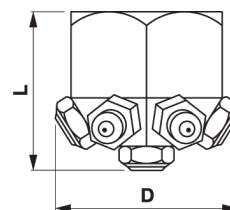

| TYPE | DIMENSION | | PRESSURE (bar) | | | | | | | | | |
|-----------------|-----------|----|------------------|------|------|------|------|-----|-----|------|------|------|
| | | | 1 | 2 | 3 | 4 | 5 | 7 | 10 | A mm | B mm | C mm |
| | D | L | CAPACITY (l/min) | | | | | | | | | |
| 3/4 - 7B - 1 | 48 | 43 | 3.15 | 4.3 | 5.2 | 6 | 6.5 | 7.7 | 9 | 1 | 1.5 | 1 |
| | | | | | | | | | | 1.5 | 2 | 1.4 |
| | | | | | | | | | | 2.5 | 2.5 | 1.5 |
| | | | | | | | | | | 3.5 | 3.5 | 1.6 |
| 3/4 - 7B - 3 | 48 | 43 | 9.1 | 12.6 | 15.5 | 17.5 | 19.6 | 23 | 27 | 1 | 2.5 | 1.6 |
| | | | | | | | | | | 1.5 | 3 | 2 |
| | | | | | | | | | | 2.5 | 3.2 | 2.1 |
| | | | | | | | | | | 3.5 | 3.5 | 2.3 |
| 3/4 - 7B - 5 | 48 | 46 | 15.0 | 21.7 | 26.0 | 29.5 | 32.9 | 36 | 45 | 1 | 3 | 1.9 |
| | | | | | | | | | | 1.5 | 3.3 | 1.1 |
| | | | | | | | | | | 2.5 | 3.6 | 2.4 |
| | | | | | | | | | | 3.5 | 3.8 | 2.5 |
| 1 - 7B - 10 | 56 | 68 | 31.5 | 42.7 | 51.8 | 60 | 65 | 77 | 90 | 1 | 2.1 | 1.5 |
| | | | | | | | | | | 1.5 | 3 | 2 |
| | | | | | | | | | | 2.5 | 3.5 | 2.5 |
| | | | | | | | | | | 3.5 | 4.5 | 2.8 |
| 1 1/2 - 7B - 25 | 105 | 83 | 77.7 | 106 | 130 | 147 | 161 | 189 | 224 | 1 | 4 | 2.7 |
| | | | | | | | | | | 1.5 | 4.8 | 3.2 |
| | | | | | | | | | | 2.5 | 5.2 | 3.3 |
| | | | | | | | | | | 3.5 | 5.3 | 3.5 |
| 1 1/2 - 7B - 32 | 105 | 85 | 99.5 | 137 | 168 | 190 | 210 | 244 | 286 | 1 | 4 | 2.7 |
| | | | | | | | | | | 1.5 | 4.8 | 3.2 |
| | | | | | | | | | | 2.5 | 5.2 | 3.3 |
| | | | | | | | | | | 3.5 | 5.3 | 3.5 |
| 1 1/2 - 7B - 40 | 105 | 85 | 124 | 168 | 210 | 239 | 258 | 308 | 358 | 1 | 4 | 2.7 |
| | | | | | | | | | | 1.5 | 4.8 | 3.2 |
| | | | | | | | | | | 2.5 | 5.2 | 3.3 |
| | | | | | | | | | | 3.5 | 5.3 | 3.5 |

SISTEMI DI LAVAGGIO ROTANTI

ROTATING WASHING HEADS

BOQUILLAS ROTATIVAS

| | |
|--|-------|
| LSE SFERE DI LAVAGGIO ROTANTI ROTATING WASHING HEADS BOQUILLAS ROTATIVAS | p. 10 |
| LSD - thread SFERE DI LAVAGGIO ROTANTI (filettatura femmina) ROTATING WASHING HEADS (female threaded) BOQUILLAS ROTATIVAS (Rosca hembra) | p. 11 |
| LSD - clip/weld SFERE DI LAVAGGIO ROTANTI (connessioni clip e a saldare) ROTATING WASHING HEADS (clip and welding connection) BOQUILLAS ROTATIVAS (Conexión clip o a soldar) | p. 12 |
| LSMOD3L SFERE DI LAVAGGIO ROTANTI ROTATING TANK WASHER BOQUILLAS ROTATIVA | p. 13 |
| LSMOD1 SFERE DI LAVAGGIO ROTANTI ROTATING WASHING HEADS BOQUILLAS ROTATIVAS | p. 14 |
| M6LSD MICRO-SFERE DI LAVAGGIO ROTANTI MICRO-ROTATING WASHING HEADS MICRO-BOQUILLAS ROTATIVAS | p. 15 |
| LSN SFERE DI LAVAGGIO ROTANTI ROTATING WASHING HEADS BOQUILLAS ROTATIVAS | p. 16 |
| LSB SFERE DI LAVAGGIO ROTANTI ROTATING WASHING HEADS BOQUILLAS ROTATIVAS | p. 17 |
| LSMOD3G SFERE DI LAVAGGIO ROTANTI ROTATING WASHING HEADS BOQUILLAS ROTATIVAS | p. 18 |
| LSMOD5B SFERE DI LAVAGGIO ROTANTI ROTATING WASHING HEADS BOQUILLAS ROTATIVAS | p. 19 |
| FTESTA SFERE DI LAVAGGIO ROTANTI ROTATING WASHING HEADS BOQUILLAS ROTATIVAS | p. 20 |
| MLF SFERE DI LAVAGGIO ROTANTI ROTATING WASHING HEADS BOQUILLAS ROTATIVAS | p. 21 |
| ALSA SFERE DI LAVAGGIO ROTANTI RETRATTILE RETRACTABLE ROTATING WASHING HEADS BOQUILLAS ROTATIVAS RETRACTIL | p. 22 |
| ALSAPA1 SFERE DI LAVAGGIO ROTANTI RETRATTILE RETRACTABLE ROTATING WASHING HEADS BOQUILLAS ROTATIVAS RETRACTIL | p. 23 |
| FLSW SFERE DI LAVAGGIO ROTANTI ROTATING WASHING HEADS BOQUILLAS ROTATIVAS | p. 24 |

LSE

Caratteristiche

Le teste rotanti LSE sono costruite in acciaio inossidabile AISI 316L, e sono montate su doppia corona di sfere, per avere una corretta rotazione in qualsiasi posizione di montaggio. Tutte le superfici interne ed esterne sono lavorate ad alta precisione garantendo una finitura perfettamente liscia e priva di zone in cui si possono accumulare residui di acqua. La velocità di rotazione dipende dalla pressione del fluido di lavaggio, che deve essere limitata: una rotazione troppo veloce causa infatti rottura del getto in gocce e perdita di forza di impatto.

Applicazioni

- Lavaggio serbatoi

Materiali

- Aisi316L
- altri a richiesta

Characteristics

The LSE rotating heads are built in AISI 316L stainless steel, and are mounted on double ball bearing, to have a correct rotation in any mounting position. All the internal and external surfaces are machined with high precision, ensuring a perfectly smooth finish and free of areas where they can accumulate water residue. The speed of rotation depends on the pressure of the washing fluid, which must be limited: a rotation too fast in fact causes breakage of the jet into drops and loss of impact strength.

Application:

- Tank washing

Materials:

- Aisi316L
- other on request

Características

Las boquillas rotativas LSE están fabricadas en acero inoxidable AISI 316L y están montadas en una doble hilera de bolas, para tener una correcta rotación en cualquier posición de montaje. Todas las superficies internas y externas se mecanizan con alta precisión asegurando un acabado perfectamente liso, sin áreas en las que se puedan acumular los residuos del agua. La velocidad de rotación depende de la presión del fluido de lavado, que debe limitarse: una rotación demasiado rápida hace que el chorro se rompa en gotas y pierda fuerza de impacto.

Aplicación:

- Lavado de tanques

Materiales:

- Aisi316L
- otros bajo pedido



Certifications: ATEX, FDA, EC1935/2004

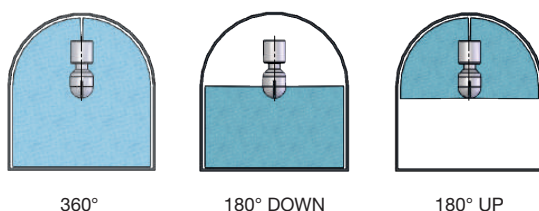
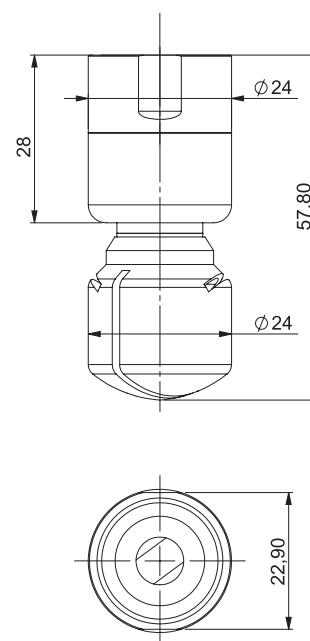

| Mod. | Capacity (lpm) at different pressure (bar) | | | | | CONNECTION | COVERAGE | MAX. WET RADIUS (MT.) |
|----------|--|----|-----------|----|----|------------|----------|-----------------------|
| | 1 | 2 | 3 | 4 | 5 | | | |
| A2LSE48D | 28 | 39 | 48 | 56 | 62 | 3/8" BSP | 180 DOWN | 2 |
| A2LSE48T | 28 | 39 | 48 | 56 | 62 | 3/8" BSP | 360 | 2 |
| A2LSE48U | 28 | 39 | 48 | 56 | 62 | 3/8" BSP | 180 UP | 2 |
| A3LSE48D | 28 | 39 | 48 | 56 | 62 | 1/2" BSP | 180 DOWN | 2 |
| A3LSE48T | 28 | 39 | 48 | 56 | 62 | 1/2" BSP | 360 | 2 |
| A3LSE48U | 28 | 39 | 48 | 56 | 62 | 1/2" BSP | 180 UP | 2 |

LSD thread

Caratteristiche

Le teste rotanti LSD sono montate su doppia corona di sfere, per avere una corretta rotazione in qualsiasi posizione di montaggio. La parte rotante ha la peculiarità di non avere linee di accoppiamento e saldature, non gradite soprattutto nel settore alimentare e o farmaceutico. La velocità di rotazione dipende dalla pressione del fluido di lavaggio, che deve essere limitata: una rotazione troppo veloce causa infatti rottura del getto in gocce e conseguente perdita di forza di impatto.

Applicazioni

- Lavaggio serbatoi

Materiali

- Aisi316L

Characteristics

The LSD rotating heads are mounted on double ball bearing, to have a correct rotation in any mounting position. The rotating part has the peculiarity of not having coupling lines and welds, not especially appreciate in the food and pharmaceutical sector. The speed of rotation depends on the pressure of the washing fluid, which must be limited: a rotation too fast in fact causes breakage of the jet into drops and loss of impact strength.

Application:

- Tank washing

Materials:

- Aisi316L

Características

Las cabezas giratorias LSD están montadas en doble rodamiento de bolas, tener una rotación correcta en cualquier posición de montaje. La parte giratoria tiene la peculiaridad de no tener líneas de acoplamiento y soldaduras, especialmente no apreciar en el sector alimentario y farmacéutico. La velocidad de rotación depende de la presión del fluido de lavado, que debe limitarse: una rotación demasiado rápida en realidad causa la rotura del chorro en gotas y la pérdida de resistencia al impacto.

Aplicación:

- Lavado de tanques

Materiales:

- Aisi316L



Certifications: ATEX, FDA, EC1935/2004

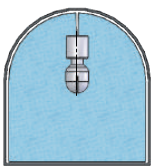
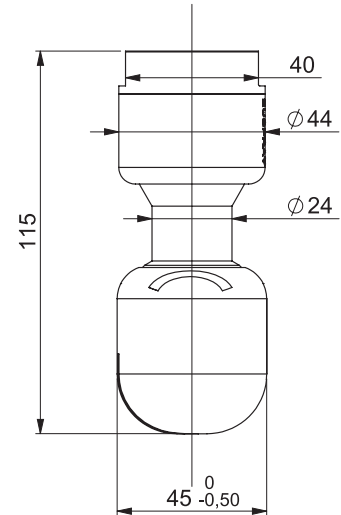

360°

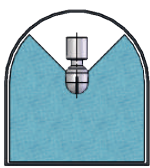

270° DOWN

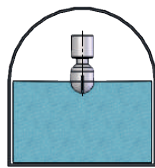

180° DOWN

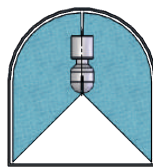

270° UP

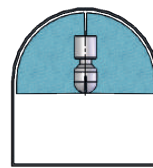

180° UP

| CODE | Capacity (lpm) at different pressure (bar) | | | COVERAGE | | | | | CONNECTION | MAX RAY WET (meters) |
|----------|--|------------|-----|----------|---------|-----------|---------|-----------|------------|----------------------|
| | 2 | 3 | 4 | 360° | 180° UP | 180° DOWN | 270° UP | 270° DOWN | | |
| A3LSD63 | 51 | 63 | 73 | T | U | D | UW | DW | 1/2 | 2,9 |
| A4LSD63 | 51 | 63 | 73 | T | U | D | UW | DW | 3/4 | 2,9 |
| A3LSD90 | 73 | 90 | 104 | T | U | D | UW | DW | 1/2 | 3,2 |
| A4LSD90 | 73 | 90 | 104 | T | U | D | UW | DW | 3/4 | 3,2 |
| A5LSD90 | 73 | 90 | 104 | T | U | D | UW | DW | 1 | 3,2 |
| A4LSD135 | 110 | 135 | 156 | T | U | D | UW | DW | 3/4 | 3,5 |
| A5LSD135 | 110 | 135 | 156 | T | U | D | UW | DW | 1 | 3,5 |

LSD clip/weld

Caratteristiche

Ha le stesse caratteristiche del modello filettato nella pagina precedente ma con possibili attacchi a clip e a saldare secondo le normative Europee (ISO2037) e Americane (BPE-US).

Applicazioni

- Lavaggio serbatoi

Materiali

- Aisi316L
- altri a richiesta

Characteristics

It has the same characteristics as the threaded model on the previous page but with possible clip and solder connections according to European (ISO2037) and American (BPE-US) standards.

Application:

- Tank washing

Materials:

- Aisi316L
- other on request

Características

Tiene las mismas características que el modelo con rosca en la página anterior, pero con posibles conexiones de clips y soldaduras de acuerdo con los estándares europeos (ISO2037) y estadounidenses (BPE-EE. UU.).

Aplicación:

- Lavado de tanques

Materiales:

- Aisi316L
- otros bajo pedido



CLIP

WELD

Certifications: ATEX, FDA, EC1935/2004

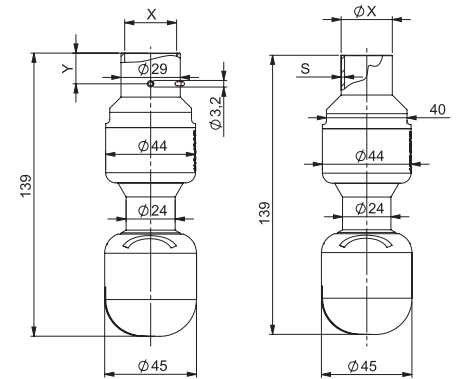
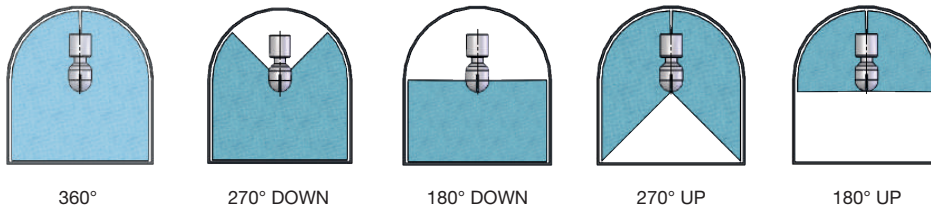

CLIP VERSIONS

| CODE | Capacity (lpm) at different pressure (bar) | | | COVERAGE | | | | | CONNECTION | NORM | X (mm) | Y (mm) | MAX RAY WET (mt.) |
|-------------|--|------------|-----|----------|---------|-----------|---------|-----------|------------|----------|--------|--------|-------------------|
| | 2 | 3 | 4 | 360° | 180° UP | 180° DOWN | 270° UP | 270° DOWN | | | | | |
| ADC25LSD63 | 51 | 63 | 73 | T | U | D | UW | DW | 1" (DN25) | ISO2037 | 25,3 | 15 | 2,9 |
| AAC25LSD63 | 51 | 63 | 73 | T | U | D | UW | DW | 1" (DN25) | BPE (US) | 25,7 | 15 | 2,9 |
| ADC25LSD690 | 73 | 90 | 104 | T | U | D | UW | DW | 1" (DN25) | ISO2037 | 25,3 | 15 | 3,2 |
| AAC25LSD690 | 73 | 90 | 104 | T | U | D | UW | DW | 1" (DN25) | BPE (US) | 25,7 | 15 | 3,2 |
| ADC25LSD135 | 110 | 135 | 156 | T | U | D | UW | DW | 1" (DN25) | ISO2037 | 25,3 | 15 | 3,5 |
| AAC25LSD135 | 110 | 135 | 156 | T | U | D | UW | DW | 1" (DN25) | BPE (US) | 25,7 | 15 | 3,5 |

WELDING VERSIONS

| CODE | Capacity (lpm) at different pressure (bar) | | | COVERAGE | | | | | CONNECTION | NORM | X (mm) | S (mm) Thickness | MAX RAY WET (mt.) |
|-------------|--|------------|-----|----------|---------|-----------|---------|-----------|------------|----------|--------|------------------|-------------------|
| | 2 | 3 | 4 | 360° | 180° UP | 180° DOWN | 270° UP | 270° DOWN | | | | | |
| AWD25LSD63 | 51 | 63 | 73 | T | U | D | UW | DW | 1" (DN25) | ISO2037 | 25 | 1,2 | 2,9 |
| AWA25LSD63 | 51 | 63 | 73 | T | U | D | UW | DW | 1" (DN25) | BPE (US) | 25,4 | 1,65 | 2,9 |
| AWD25LSD90 | 73 | 90 | 104 | T | U | D | UW | DW | 1" (DN25) | ISO2037 | 25 | 1,2 | 3,2 |
| AWA25LSD90 | 73 | 90 | 104 | T | U | D | UW | DW | 1" (DN25) | BPE (US) | 25,4 | 1,65 | 3,2 |
| AWD25LSD135 | 110 | 135 | 156 | T | U | D | UW | DW | 1" (DN25) | ISO2037 | 25 | 1,2 | 3,5 |
| AWA25LSD135 | 110 | 135 | 156 | T | U | D | UW | DW | 1" (DN25) | BPE (US) | 25,4 | 1,65 | 3,5 |

LSMOD3L

Caratteristiche

Le teste rotanti sono costruite in acciaio inossidabile aisi 316, sono montate su cuscinetti a sfere. Tutte le superfici interne ed esterne sono lavorate con macchine utensili ad alta precisione garantendo una finitura liscia e un'ottima qualità del prodotto. Le teste sono disponibili con attacco filetto femmina o maschio BSP (GAS).

Applicazioni

- Lavaggio serbatoi

Materiali

- Aisi316L
- altri a richiesta

Characteristics

The rotating heads are made of stainless steel AISI 316 and they are placed on two spherical bearings. All the internal and external surfaces are machined worked with accuracy and they are smooth. The heads are available in two different connections: female or male thread BSP (GAS).

Application:

- Tank washing

Materials:

- Aisi316L
- other on request

Características

Las cabezas giratorias están construidos en acero inoxidable AISI 316, y se montan sobre cojinetes de bolas. Todas las superficies internas y externas están trabajadas con máquinas herramienta de alta precisión que garantizan un acabado liso y una excelente calidad de producto. Los cabezales se presentan con conexión de rosca hembra o macho BSP (GAS).

Aplicación:

- Lavado de tanques

Materiales:

- Aisi316L
- otros bajo pedido

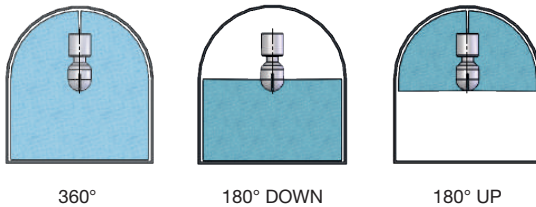
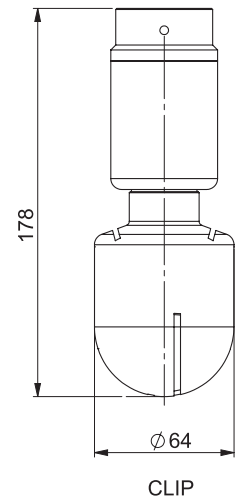
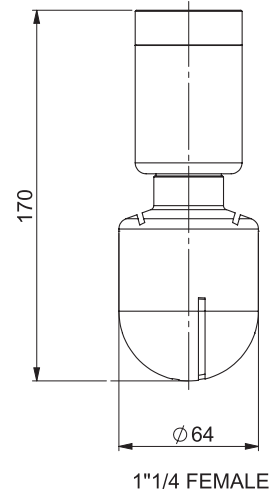

| ARTICLE CODE | Capacity | | Pressure | Coverage | Max ray wet | Thread | |
|--------------------|----------|-------|--------------|----------|-------------|--------------|---------------|
| | 1 | 2 | 3 | | Wet | Female (BSP) | Clip (mm) |
| ALSMOD 3L.1 | 200 | 258 | 300 | 360° | 3.2 + 4.6 | 1 1/4" | |
| ALSMOD 3L.2 | 133,3 | 196,6 | 233,3 | 180° | 3.2 + 4.6 | 1 1/4" | |
| ALSMOD 3L.3 | 200 | 258 | 300 | 360° | 3.2 + 4.6 | | Ø 38.5 + 40.5 |
| ALSMOD 3L.4 | 133,3 | 196,6 | 233,3 | 180° | 3.2 + 4.6 | | Ø 38.5 + 40.5 |

LSMOD1

Caratteristiche

Tali teste sono costituite da una piccola sfera di lavaggio di forma toroidale: essa può essere inserita in un'apertura di soli 25 mm di diametro. L'attacco è 1/4" gas maschio. L'ingombro è minimo: lunghezza totale 50 mm, diametro massimo 25 mm, peso 40 grammi.

Applicazioni

- Lavaggio serbatoi

Materiali

- Aisi316L
- Aisi316L o PEEK o PTFE

Characteristics

Such heads are made by a small toroidal head: it can pass through an opening of only 25 mm of diameter. The connection is 1/4" gas male. Reduced overall dimension: total length is 50 mm, weight 40 grams, diameter 25 mm.

Application:

- Tank washing

Materials:

- Aisi316L
- Aisi316L or PEEK or PTFE

Características

Dichos cabezales se hacen con un pequeño cabezal toroidal: puede pasar a través de una abertura de tan sólo 25 mm de diámetro. La conexión es de 1/4 gas macho. Las dimensiones reducidas totales son de 50 mm de largo, 40 gramos de peso y 25 mm de diámetro.

Aplicación:

- Lavado de tanques

Materiales:

- Aisi316L
- Aisi316L o PEEK o PTFE

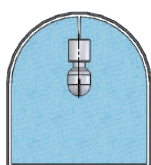
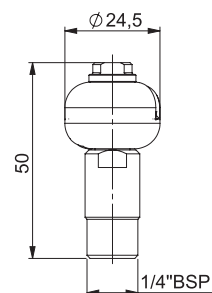

360°

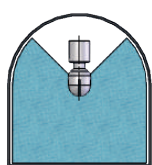

270° DOWN

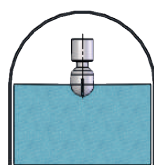

180° DOWN

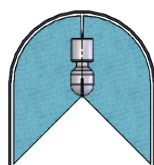

270° UP

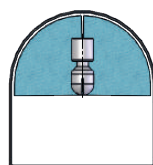

180° UP

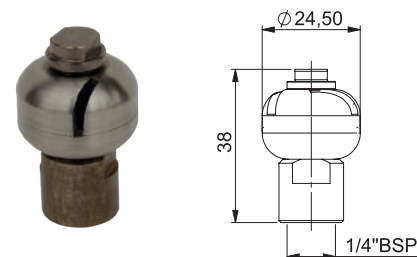

| CODE | Capacity (lpm) at different pressure (bar) | | | | | | | CONNECTION | COVERAGE |
|------------|--|------|-------------|------|------|------|------|------------|-----------|
| | 1 | 2 | 3 | 4 | 5 | 6 | 8 | | |
| LSMOD1.1 | 13,3 | 18,8 | 23,0 | 26,6 | 29,7 | 32,5 | 37,6 | 1/4" M | 360° |
| LSMOD1.2 | 11,5 | 16,3 | 20,0 | 23,1 | 25,8 | 28,3 | 32,7 | 1/4" M | 360° |
| LSMOD1.3 | 11,5 | 16,3 | 20,0 | 23,1 | 25,8 | 28,3 | 32,7 | 1/4" M | 180° UP |
| LSMOD1.4 | 11,5 | 16,3 | 20,0 | 23,1 | 25,8 | 28,3 | 32,7 | 1/4" M | 180° DOWN |
| LSMOD1.5 | 16,5 | 23,4 | 28,6 | 33,0 | 36,9 | 40,4 | 46,7 | 1/4" M | 360° |
| LSMOD1.6 | 16,5 | 23,4 | 28,6 | 33,0 | 36,9 | 40,4 | 46,7 | 3/8" F | 360° |
| LSMOD1.7 | 11,5 | 16,3 | 20,0 | 23,1 | 25,8 | 28,3 | 32,7 | 1/4" M | 130° UP |
| LSMOD1.8 | 11,5 | 16,3 | 20,0 | 23,1 | 25,8 | 28,3 | 32,7 | 1/4" M | 90° DOWN |
| LSMOD1F1.9 | 6,5 | 9,1 | 11,2 | 12,9 | 14,5 | 15,8 | 18,3 | 1/4" F | 270° DOWN |
| LSMOD1F2.0 | 6,0 | 8,5 | 10,4 | 12,0 | 13,4 | 14,7 | 17,0 | 1/4" F | 270° DOWN |

MICRO

M6LSD

Caratteristiche

Le teste di lavaggio M6LSD sono state sviluppate per il lavaggio di file, bocchetti e piccoli vani con apertura di 10 mm. La testa rotante è costruita interamente in acciaio inossidabile AISI 316 oppure con lo stelo in AISI 316 e la parte rotante in PEEK. La finitura liscia e di ottima qualità garantisce una rotazione perfetta anche senza cuscinetti a sfere. La testa è disponibile attacco filettato maschio M6.

Applicazioni

- Lavaggio fiale, piccoli contenitori

Materiali

- Aisi316L
- Aisi316L o PEEK

Characteristics

The rotating heads M6LSD have been developed for washing vials, small bottles and small compartments with 10 mm opening. The rotating head is made entirely of stainless steel AISI 316 or with the stem in AISI 316 and the rotating part in PEEK. The smooth and high quality finish guarantees perfect rotation even without ball bearings. The head is available M6 male threaded connection.

Application:

- Wash vials, small containers

Materials:

- Aisi316L
- Rotor: Aisi316L or PEEK

Características

Las cabezas de lavado M6LSD han sido desarrolladas para lavar filamentos, botellas pequeñas y pequeños compartimentos con 10 mm de apertura. La cabeza giratoria está hecha completamente de acero inoxidable AISI 316 o con el vástago en AISI 316 y la parte giratoria en PEEK. El acabado liso y de alta calidad garantiza una rotación perfecta incluso sin rodamientos de bolas. El cabezal está disponible con conexión roscada macho M6.

Aplicación:

- Lavado de viales, contenedores pequeños

Materiales:

- Aisi316L
- Aisi316L o PEEK

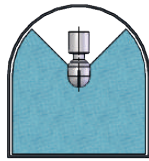
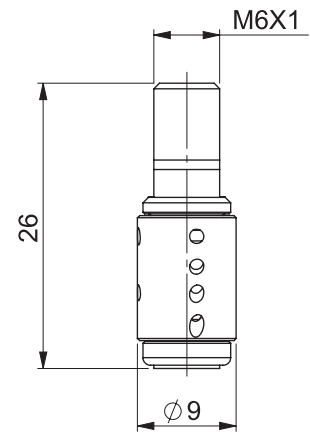

270° DOWN

| Mod. | MATERIAL | | Capacity (lpm) at different pressure (bar) | | | | | CONNECTION | COVERAGE |
|-----------|----------|----------|--|-----|------------|-----|-----|------------|----------|
| | BODY | ROTOR | 1 | 2 | 3 | 4 | 5 | | |
| AM6LSD9 | AISI316L | AISI316L | 4,0 | 5,6 | 6,9 | 8,0 | 9,8 | M6 | 270° |
| APKM6LSD9 | AISI316L | PEEK | 4,0 | 5,6 | 6,9 | 8,0 | 9,8 | M6 | 270° |

LSN

Caratteristiche

Le teste rotanti LSN hanno il corpo in acciaio inossidabile aisi 316L e rotore in PEEK. La finitura liscia e di ottima qualità garantisce una rotazione perfetta anche senza cuscinetti a sfere. La connessione standard della testa è filettata femmina da 3/8", a richiesta altre connessioni.

Applicazioni

- Lavaggio serbatoi

Materiali

- Aisi316L
- PEEK

Characteristics

LSN rotary heads have aISI 316L stainless steel body and PEEK rotor.

The smooth and high quality finish guarantees perfect rotation even without ball bearings.

The standard connection of the head is 3/8 "female threaded, on request other connections.

Application:

- Tank washing

Materials:

- Aisi316L
- PEEK

Caracteristicas

Las cabezas giratorias LSN tienen cuerpo de acero inoxidable 316L y rotor PEEK.

El acabado liso y de alta calidad garantiza una rotación perfecta incluso sin rodamientos de bolas.

La conexión estándar del cabezal es rosca hembra de 3/8 ", bajo pedido otras conexiones.

Aplicación:

- Lavado de tanques

Materiales:

- Aisi316L
- PEEK

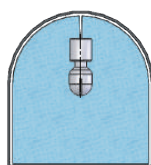
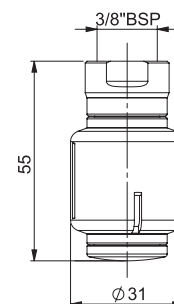

360°

| Mod. | Capacity (lpm) at different pressure (bar) | | | | | CONNECTION | COVERAGE |
|------------|--|----|-----------|----|----|------------|----------|
| | 1 | 2 | 3 | 4 | 5 | | |
| APK2FLSN14 | 8 | 11 | 14 | 16 | 18 | 3/8" BSP | 360° |
| APK2FLSN18 | 10 | 15 | 18 | 21 | 23 | 3/8" BSP | 360° |
| APK2FLSN40 | 23 | 33 | 40 | 46 | 52 | 3/8" BSP | 360° |
| APK2FLSN50 | 29 | 41 | 50 | 58 | 65 | 3/8" BSP | 360° |

LSB

Caratteristiche

La teste rotanti LSB sono realizzate in acciaio inossidabile AISI 316L con bussole in teflon per ridurre la rumorosità e l'attrito. Tutte le superfici interne ed esterne sono lavorate con macchine utensili ad alta precisione garantendo una finitura liscia e un'ottima qualità del prodotto. La connessione standard è di 1/2" BSP femmina.

Applicazioni

- Lavaggio serbatoi

Materiali

- Aisi316L
- altri a richiesta

Characteristics

LSB rotary heads are made of AISI 316L stainless steel with teflon bushings to reduce noise and friction. All internal and external surfaces are machined with high precision machine tools ensuring a smooth finish and excellent product quality. The standard connection is 1/2" BSP female.

Application:

- Tank washing

Materials:

- Aisi316L
- other on request

Características

Las cabezas giratorias LSB están hechas de acero inoxidable AISI 316L con casquillos de teflón para reducir el ruido y la fricción. Todas las superficies internas y externas están mecanizadas con máquinas herramienta de alta precisión que garantizan un acabado uniforme y una excelente calidad del producto. La conexión estándar es de 1/2" «BSP hembra».

Aplicación:

- Lavado de tanques

Materiales:

- Aisi316L
- otros bajo pedido

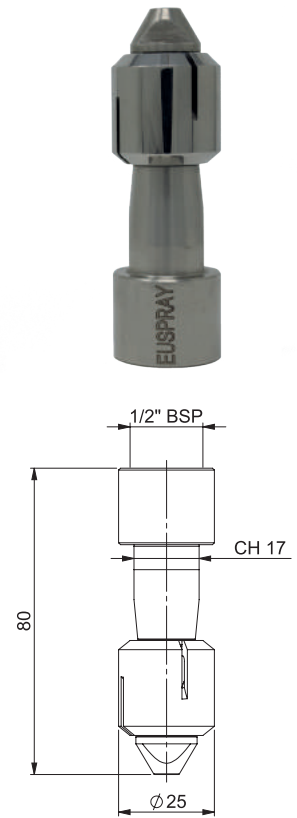
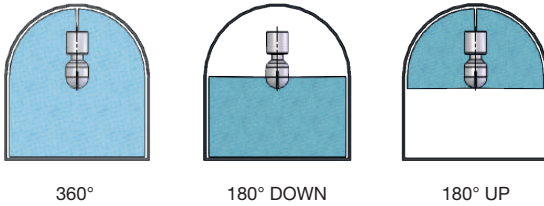

| Mod. | Capacity (lpm) at different pressure (bar) | | | | | CONNECTION | COVERAGE |
|----------|--|----|-----------|----|----|------------|-----------|
| | 1 | 2 | 3 | 4 | 5 | | |
| A3LSB25T | 14 | 20 | 25 | 29 | 32 | 1/2" BSP | 360° |
| A3LSB25D | 14 | 20 | 25 | 29 | 32 | 1/2" BSP | 180° DOWN |
| A3LSB25U | 14 | 20 | 25 | 29 | 32 | 1/2" BSP | 180° UP |

LSMOD3G

Caratteristiche

La teste rotanti LSB sono realizzate in acciaio inossidabile AISI 316L con bussole in teflon per ridurre la rumorosità e l'attrito. Tutte le superfici interne ed esterne sono lavorate con macchine utensili ad alta precisione garantendo una finitura liscia e un'ottima qualità del prodotto. La connessione standard è di 1/2" BSP femmina.

Applicazioni

- Lavaggio serbatoi

Materiali

- Aisi304 o Aisi316L

Characteristics

LSB rotary heads are made of AISI 316L stainless steel with teflon bushings to reduce noise and friction. All internal and external surfaces are machined with high precision machine tools ensuring a smooth finish and excellent product quality. The standard connection is 1/2" BSP female.

Application:

- Tank washing

Materials:

- Aisi304 or Aisi316L

Características

Las cabezas giratorias LSB están hechas de acero inoxidable AISI 316L con casquillos de teflón para reducir el ruido y la fricción. Todas las superficies internas y externas están mecanizadas con máquinas herramienta de alta precisión que garantizan un acabado uniforme y una excelente calidad del producto. La conexión estándar es de 1/2" BSP hembra.

Aplicación:

- Lavado de tanques

Materiales:

- Aisi304 o Aisi316L

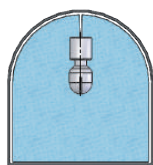
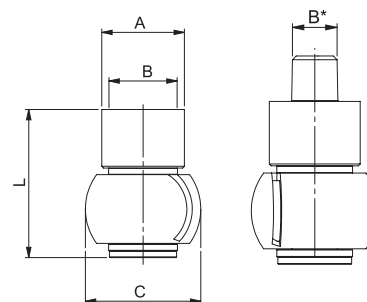

360°

| Mod. | Capacity (lpm) at different pressure (bar) | | | | | COVERAGE | MAX. WET RADIUS (MT.) | Dimensions (mm) | | | |
|-----------|--|----|-----------|----|----|----------|-----------------------|-----------------|----------------------|----|----|
| | 1 | 2 | 3 | 4 | 5 | | | A | B | C | L |
| LSMOD3G.1 | 31 | 44 | 54 | 62 | 69 | 360° | 1,5 | 24 | 1/2" BSP | 34 | 43 |
| LSMOD3G.2 | 31 | 44 | 54 | 62 | 69 | 360° | 1,5 | 20 | 3/8" BSP | 34 | 43 |
| LSMOD3G.3 | 31 | 44 | 54 | 62 | 69 | 360° | 1,5 | 20 | 1/4" BSP | 34 | 54 |
| LSMOD3G.4 | 31 | 44 | 54 | 62 | 69 | 360° | 1,5 | 24 | CLIP: dia. 13,5 - 22 | 34 | 43 |

LSMOD5B

Caratteristiche

La testa rotante è costruita in acciaio inossidabile AISI 304 o POM. La testa è disponibile con clip di attacco rapido o da saldare.

Le teste di lavaggio ALSMOD5 ruotano su dei cuscinetti in teflon che garantiscono una rotazione eccellente e un basso livello di rumorosità. Sono anche dotate di clip per facilitare lo smontaggio e semplici manutenzioni di routine

Applicazioni

- Lavaggio serbatoi

Materiali

- Aisi304 o POM

Characteristics

The rotating head is constructed in AISI 304 stainless steel or POM.

The head is available with quick clips from attack or welding.

The washing heads ALSMOD5 rotate on drag bearings in teflon which guarantee an excellent rotation and a low noise. They also have clips to facilitate disassembly and simple routine maintenance operations.

Application:

- Tank washing

Materials:

- Aisi304 or POM

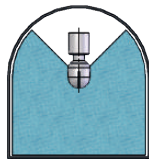

270° DOWN

Características

La boquilla rotativa está construida en acero inoxidable AISI 304 o POM.

El cabezal está disponible con clips rápidos de ataque o soldadura. Los cabezales de lavado ALSMOD5 rotan sobre cojinetes de teflón que garantizan una excelente rotación y una baja emisión de ruido. Disponen de clips para facilitar el desmontaje y las simples operaciones de mantenimiento.

Aplicación:

- Lavado de tanques

Materiales:

- Aisi304 o POM

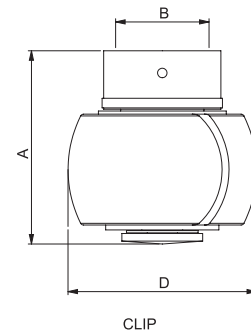
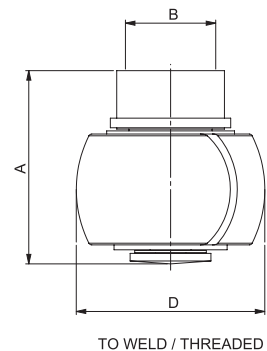

| Mod. | Capacity (lpm) at different pressure (bar) | | | | | CONNECTION | COVERAGE | MAX. WET RADIUS (MT.) | Dimensions (mm) | | | MATERIAL |
|------------|--|-----|-----|------------|-----|------------|-----------|-----------------------|-----------------|--------|------|----------|
| | 0,5 | 1 | 2 | 3 | 4 | | | | A | B | D | |
| LSMOD5B.1 | 65 | 87 | 101 | 120 | 141 | WELD | 270° DOWN | 3 | 60 | 25 | 59,5 | AISI304 |
| LSMOD5A.1 | 65 | 87 | 101 | 120 | 141 | CLIP | 270° DOWN | 3 | 60 | 28 | 59,5 | AISI304 |
| LSMOD5A.2 | 70 | 91 | 108 | 125 | 165 | CLIP | 270° DOWN | 3 | 60 | 28 | 59,5 | AISI304 |
| PLSMOD5A.3 | 120 | 170 | 230 | 294 | 320 | THREAD | 270° DOWN | 4 | 90 | 1-1/4" | 89 | POM |

FTESTA

Caratteristiche

La testa rotante "TF" è costruita interamente in teflon. La finitura liscia e di ottima qualità garantisce una rotazione perfetta anche senza cuscinetti a sfere. La connessione standard è filettata da 1/2". Il flusso di lavaggio prodotto dalla testa rotante genera il moto di rotazione grazie alla forza di reazione dei getti a spillo a elevata forza d'impatto. La velocità di rotazione dipende dalla pressione del fluido di lavaggio.

Applicazioni

- Lavaggio serbatoi

Materiali

- PTFE (Teflon)

Characteristics

The rotating head "TF" are made entirely in teflon. The smooth finish and excellent quality ensures a perfect rotation even without ball bearings. The standard connections is threaded 1/2". The flow of washing from the rotating head generates the motion of rotation thanks to the reaction force of the needle jets with high impact force. The rotation speed depends from the pressure of the washing fluid.

Application:

- Tank washing

Materials:

- PTFE (Teflon)

Características

Boquilla rotativa "TF" está fabricada en teflón en su totalidad. El fino acabado y la excelente calidad aseguran una perfecta rotación incluso sin cojinetes de bolas. La conexión estándar es de rosca 1/2". El flujo de lavado del cabezal giratorio genera el movimiento de rotación gracias a la fuerza de reacción de los jets de aguja con una gran fuerza de impacto. La velocidad de rotación depende de la presión del líquido de lavado.

Aplicación:

- Lavado de tanques

Materiales:

- PTFE (Teflon)

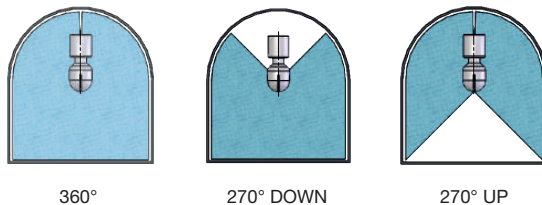

3F



42



120

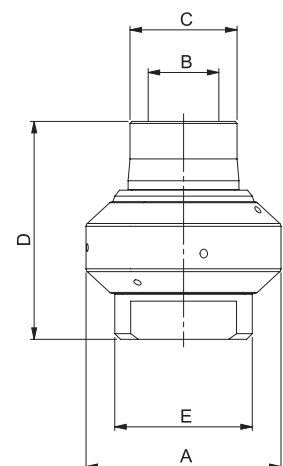

| Mod. | Capacity (lpm) at different pressure (bar) | | | | | COVERAGE | MAX. WET RADIUS (MT.) | Dimensions (mm) | | | | |
|----------------|--|----|-----|-----|-----|-----------|-----------------------|-----------------|----------|----|----|----|
| | 1 | 2 | 3 | 4 | 5 | | | A | B | C | D | E |
| TF3FTESTA3F | 14 | 20 | 25 | 29 | 32 | 360° | 2 | 51 | 1/2" BSP | 29 | 57 | 37 |
| TF3FTESTA4FSUP | 14 | 20 | 25 | 29 | 32 | 270° UP | 2 | 51 | 1/2" BSP | 29 | 57 | 37 |
| TF3FTESTA4FINF | 14 | 20 | 25 | 29 | 32 | 270° DOWN | 2 | 51 | 1/2" BSP | 29 | 57 | 37 |
| TF3FTESTAA42 | 14 | 20 | 25 | 29 | 32 | 360° | 2 | 42 | 1/2" BSP | 29 | 57 | 33 |
| TF4FTESTA120 | 69 | 98 | 120 | 139 | 155 | 360° | 3 | 58 | 3/4" BSP | 36 | 60 | 42 |

MLF

Caratteristiche

La nuova conformazione dell'ugello rotante per lavaggio forni è stata attentamente progettata per ottenere un getto particolarmente uniforme e con una ottimale distribuzione delle gocce a pressioni medio basse. La direzione dei getti degli ugelli installati, è orientata per avere una copertura praticamente totale, un buon impatto, bassi consumi di acqua e ridotte velocità di rotazione. Non vi sono componenti di tenuta in materiale plastico od elastomeri, per cui la permanenza dell'ugello ad alte temperature non influenza minimamente il funzionamento. Le portate del sistema rotante per lavaggio forni sono legate al tipo di ugelli finali installati alle estremità, da individuare a seconda delle dimensioni del forno, dalle caratteristiche dell'impianto di alimentazione di questo ugello e dalle effettive esigenze di lavaggio.

Applicazioni

- Lavaggio forni

Materiali

- Aisi316L
- altri a richiesta

Characteristics

The new shape of the rotating nozzle for washing ovens has been carefully designed to obtain a particularly uniform jet and with an optimal distribution of the drops at medium-low pressure. The direction of the nozzle jets installed, is oriented to have a covering practically total, a good impact, low water consumption and reduced speed rotation. There are no sealing components made of plastic or elastomers, so that the nozzle stay at high temperatures does not affect the operation in any way. The flow rates of the rotating oven washing system are linked to the type of final nozzles installed at the ends, to be identified according to the size of the oven, the characteristics of the feeding system of this nozzle and the actual washing requirements.

Application:

- Ovens washing

Materials:

- Aisi316L
- other on request

Características

La nueva forma de la boquilla giratoria para lavar hornos ha sido cuidadosamente diseñado para obtener un chorro particularmente uniforme y con una distribución óptima de las gotas a presión media-baja. La dirección de los jets de la boquilla instalados, está orientada a tener una cubierta prácticamente total, buen impacto, bajo consumo de agua y velocidad reducida rotación. No hay componentes de sellado hechos de plástico o elastómeros, de modo que la boquilla permanezca a altas temperaturas y no afecte la operación de ninguna manera. Las velocidades de flujo del sistema giratorio para hornos de limpieza están vinculadas con el tipo de boquillas finales instalados en los extremos, a ser identificado, dependiendo del tamaño del horno, a partir de las características del sistema de alimentación de esta boquilla y de los requisitos de lavado real.

Aplicación:

- Lavado de hornos

Materiales:

- Aisi316L
- otros bajo pedido

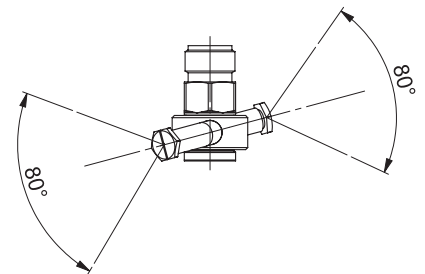
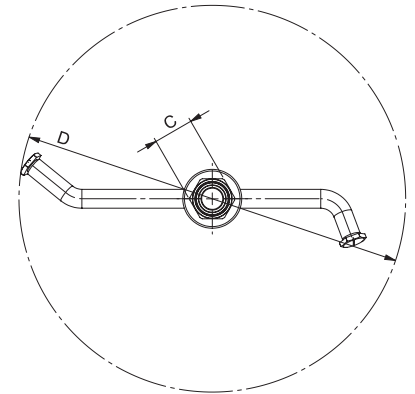
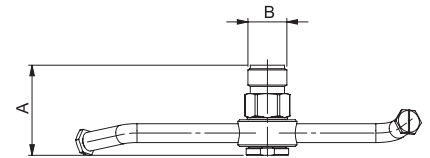

| Mod. | Capacity (lpm) at different pressure (bar) | | | | | COVERAGE | Dimensions (mm) | | | |
|----------------|--|-----|------------|-----|-----|----------|-----------------|------------|----|-----|
| | 1 | 2 | 3 | 4 | 5 | | A | B | C | D |
| A2MLF38 | 2,2 | 3,1 | 3,8 | 4,4 | 4,9 | 110° | 40 | 3/8" M BSP | 17 | 165 |
| A2MLF48 | 2,8 | 4,0 | 4,8 | 5,6 | 6,2 | 110° | 40 | 3/8" M BSP | 17 | 165 |
| A2MLF62 | 3,6 | 5,1 | 6,2 | 7,2 | 8,0 | 110° | 40 | 3/8" M BSP | 17 | 165 |

ALSA

RETRACTABLE

Caratteristiche

Questo sistema di lavaggio è costruito interamente in acciaio inox AISI 316, ad eccezione dell'attuatore pneumatico chiuso (ma disponibile su richiesta anche in AISI 316). La testa rotante di lavaggio è montata su due cuscinetti a sfere. Tutte le superfici interne ed esterne sono lavorate con macchine utensili ad alta precisione garantendo una finitura liscia e un'eccellente qualità del prodotto. Le teste sono disponibili in due diverse lunghezze per serbatoi a parete semplice con isolamento. Connessioni tri-clamp.

Applicazioni

- Lavaggio serbatoi

Materiali

- Aisi316L

Characteristics

This washing system is constructed entirely of stainless steel AISI 316, with the exception of the pneumatic actuator (available on request AISI 316). The rotating head cleaning is mounted on two ball bearings. All the internal and external surfaces are machined with high precision machine tools ensuring a smooth finish and an excellent quality of the product. The heads are available in two different types of length for single wall tanks and with insulation. Connections tri-clamp.

Application:

- Tank washing

Materials:

- Aisi316L

Características

Este sistema de lavado está construido en acero inoxidable AISI 316 en su totalidad, excepto el accionador neumático (disponible también en acero inoxidable AISI 316 a petición del cliente). El cabezal de lavado giratorio va montado sobre dos cojinetes de bolas. Todas las superficies internas y externas están fabricadas con máquinas de gran precisión que aseguran un fino acabado y una excelente calidad del producto. Los cabezales están disponibles en dos tipos diferentes de longitudes para tanques de pared única o con aislante. Conexiones tri-clamp.

Aplicación:

- Lavado de tanques

Materiales:

- Aisi316L

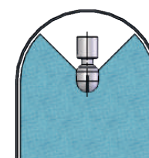

270° DOWN

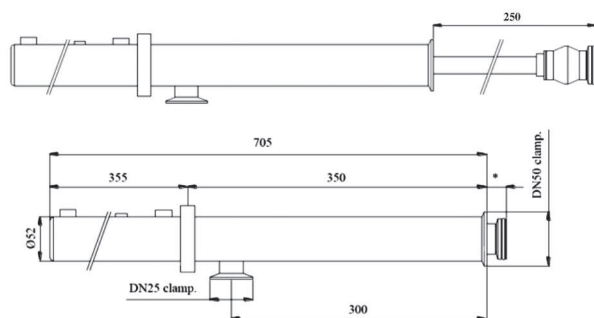

| Model | No working position (1) | Position in max washing (2) |
|-------------|-------------------------|-----------------------------|
| ALSA2550M1 | 21,5 mm | 271,5 mm |
| ALSA2550M1I | 100 mm | 350 mm |

| Model | Capacity at pressure (l/min) (bar) | | | COVERAGE degree | WASHING RAY DIN 32676 | THREAD LIQUID Clamp DIN 32676 | WALL THREAD Clamp DIN 32676 | SPEC Pared contenedor |
|-------------|------------------------------------|-----|-----|-----------------|-----------------------|-------------------------------|-----------------------------|-----------------------|
| | 1 | 2 | 3 | | | | | |
| ALSA2550M1 | 82 | 103 | 120 | 270° DOWN | 2,2 - 3,4 | DN 25 | DN 50 | NON ISOLATO |
| ALSA2550M1I | 82 | 103 | 120 | 270° DOWN | 2,2 - 3,4 | DN 25 | DN 50 | ISOLATO |

NB: massima temperatura di lavoro 95° C. Minima temperatura di lavoro 0° C.

NB: max working temperature 95° C. Min working temperature 0° C.

NB: temperatura máxima de funcionamiento 95° C. Temperatura mínima de funcionamiento 0° C.

ALSAPA

Caratteristiche

Questo sistema di lavaggio è costruito interamente in acciaio inox AISI 316. La testa rotante di lavaggio è montata su due cuscinetti a sfere. Tutte le superfici interne ed esterne sono lavorate con macchine utensili ad alta precisione garantendo una finitura liscia e un'eccellente qualità del prodotto. Le teste sono disponibili in due diverse lunghezze per serbatoi a parete semplice con isolamento. Connessioni tri-clamp.

Applicazioni

- Lavaggio serbatoi

Materiali

- Aisi316L

Characteristics

This washing system is constructed entirely of stainless steel AISI 316. The rotating head cleaning is mounted on two ball bearings. All the internal and external surfaces are machined with high precision machine tools ensuring a smooth finish and an excellent quality of the product. The heads are available in two different types of length for single wall tanks and with insulation. Connections tri-clamp.

Application:

- Tank washing

Materials:

- Aisi316L

RETRACTABLE

Características

Este sistema de lavado está construido en acero inoxidable AISI 316. El cabezal de lavado giratorio va montado sobre dos cojinetes de bolas. Todas las superficies internas y externas están fabricadas con máquinas de gran precisión que aseguran un fino acabado y una excelente calidad del producto. Los cabezales están disponibles en dos tipos diferentes de longitudes para tanques de pared única o con aislante. Conexiones tri-clamp.

Aplicación:

- Lavado de tanques

Materiales:

- Aisi316L

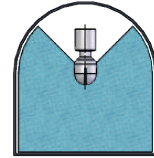

270° DOWN

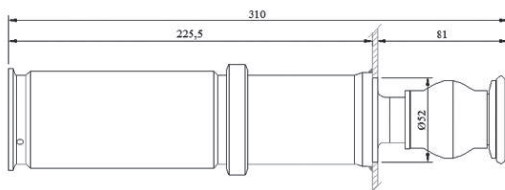
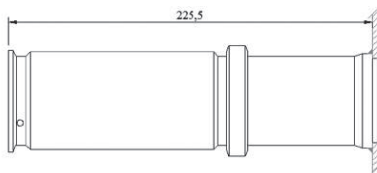

| Model | No working position (1) | Position in max washing (2) |
|------------|-------------------------|-----------------------------|
| ALSA2550M1 | 21,5 mm | 271,5 mm |

| Model | Capacity at pressure (l/min) (bar) | | | COVERAGE | WASHING RAY | THREAD LIQUID | WALL THREAD |
|---------|------------------------------------|----|-----|-----------|-------------|--------------------|-------------|
| | 1 | 2 | 3 | degree | DIN 32676 | Clamp DIN 32676 | Welding |
| ALSAPA1 | 70 | 92 | 115 | 270° DOWN | 2,2-3,4 | DN 50 | Ø 52 |

NB: massima temperatura di lavoro 95° C. Minima temperatura di lavoro 0° C.
NB: max working temperature 95° C. Min working temperature 0° C.
NB: Temperatura máxima de funcionamiento 95° C. Temperatura mínima de funcionamiento 0° C.

FLSW

Caratteristiche

La serie FLSW utilizza bassa pressione per l'applicazione di pulizia e risciacquo. Ha una solida struttura e può essere installato in diversi mercati come chimico, farmaceutico o F & B. La gamma è abbastanza varia con diverse capacità e possibilità di copertura. Grazie al suo disegno è dotata di un'alta forza di impatto per garantire lavaggi accurati.

Applicazioni

- Lavaggio alto impatto

Materiali

- Aisi316L, PTFE

Characteristics

The series FLSW utilize low pressure for cleaning and rinsing application. It has a solid construction and can be installed in different markets like chemical, pharmaceutical or F&B. The range is quite wide with different capacities and coverage possibilities. Gracias a su diseño, está equipada con una fuerza de alto impacto para garantizar un lavado preciso.

Application:

- High Impact washing

Materials:

- Aisi316L, PTFE

Características

La serie FLSW utiliza baja presión para aplicaciones de limpieza y enjuague. Tiene una construcción sólida y se puede instalar en diferentes mercados como químico, farmacéutico o F & B. El rango es bastante amplio con diferentes capacidades y posibilidades de cobertura. Thanks to its design, it is equipped with a high impact force to ensure accurate washing.

Aplicación:

- Lavado de alto impacto

Materiales:

- Aisi316L, PTFE

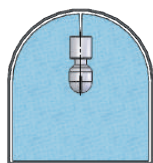

360°

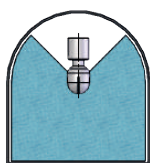

270° DOWN

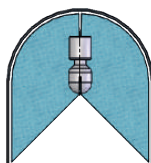

270° UP

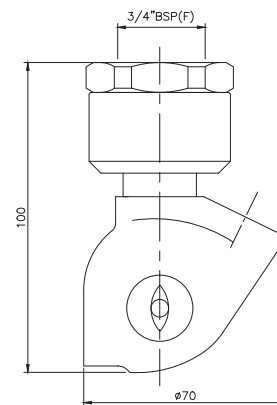

| Mod. | Capacity (lpm) at different pressure (bar) | | | | | CONNECTION | COVERAGE | | |
|------------------|--|-----|------------|-----|-----|------------|----------|---------|-----------|
| | 1 | 2 | 3 | 4 | 5 | | 360° | 270° UP | 270° DOWN |
| A4FLSW40 | 24 | 32 | 40 | 46 | 51 | 3/4" BSP | T | UW | DW |
| A4FLSW63 | 36 | 52 | 63 | 73 | 82 | 3/4" BSP | T | UW | DW |
| A4FLSW88 | 51 | 72 | 88 | 102 | 114 | 3/4" BSP | T | UW | DW |
| A4FLSW116 | 67 | 95 | 116 | 134 | 150 | 3/4" BSP | T | UW | DW |
| A4FLSW171 | 99 | 140 | 171 | 197 | 220 | 3/4" BSP | T | UW | DW |

**NOZZLES FOR
STEEL INDUSTRY**

**BOQUILLAS PARA LA
INDUSTRIA DEL ACERO**

**UGELLI PER
ACCIAIERIA**

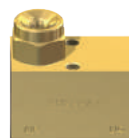

FILTERS

FILTROS

FILTRI



**AIR
NOZZLES**

**BOQUILLAS
PARA AIRE**

**UGELLI
PER ARIA**



ACCESSORIES

ACCESORIOS

ACCESSORI



We are present in the following Countries



Australia
Austria
Chile
Egypt
France
Germany
Greece
India
Indonesia
Ireland
Italy
Lituania
Poland
Czech Republic
Russia
Singapore
Slovakia
South Africa
Turkey
Ukraine

www.zerquatrolab.it



Eurospray
Edificio Conata I
c/ Frutuós Gelabert, 2-4 - 8²4^a
08970 Sant Joan Despí (Barcelona)
Tel. +34 934773846
Sales Service: export@euspray.com
www.euspray.com